

Innerware & Accessories

Innerware

Product guide

Kitchen Innerware

	Page
Corner Solutions	9.4
Base Solutions	9.9
Pantry Solutions	9.13
Wire Drawers	9.17
Wire Storage Baskets	9.18
Kitchen Accessories	9.19

Laundry Innerware

Tekno Laundry Hampers	9.20
Wire Basket Laundry Hampers	9.21

Wardrobe Innerware

Wardrobe Hanging Rail	9.22
GlideSoft RD Sliding Door Track	9.23
Titusoft SD100s	9.25
GlideSoft TP Sliding Door Track	9.27

Drawer Inserts

Kombi Cutlery Trays	9.30
Cutlery Inserts	9.34
Spice Trays	9.35
Utensil Organisers	9.36

Waste Bins

Tidy Bins	9.39
Single Pull-out Bins	9.40
Twin Pull-out Bins	9.41
Tekno Soft Close Bins	9.43
Tekno Soft Close Hampers	9.46

Kitchen Innerware Corner Solutions

- Soft close damping technology
- Non-slip trays
- Easy access to corner storage
- Suitable for door openings 450/500mm



Swivel Corner Unit

Left-hand

Right-hand

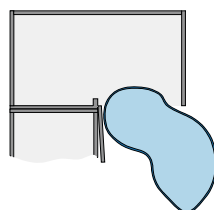
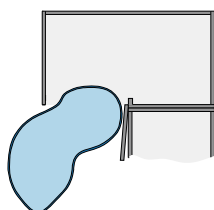
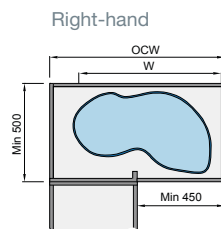
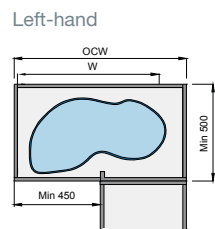

Min. internal carcass depth (mm)	Width (mm)	Weight capacity per shelf (kg)	Item number
500	900	20	607.8D25.210.090
500	900	20	607.8D25.220.090

Kitchen Innerware Corner Solutions

- Soft close damping technology
- Polished chrome steel mesh baskets
- Complete access to corner storage
- Suitable for door openings 450/500mm
- Universal left and right hand opening
- Minimum 800mm cabinet install



Full Access Corner Unit

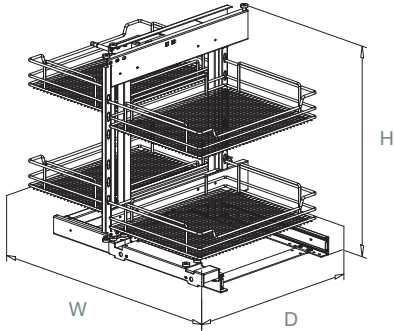

Suits outside cabinet width (mm)	Width (mm)	Depth (mm)	Height (mm)	Weight capacity per frame (kg)	Item number
450	615	525	595	20	607.8D25.595.045

Kitchen Innerware Corner Solutions

- 270° rotation
- Round trip pull-out
- Pie-cut and round cabinet applications
- Adjustable frame
- Polished chrome steel mesh baskets



Easy Reach Corner Unit

Cabinet width (mm)	Height (mm)	Weight capacity (kg)	Item number
--------------------	-------------	----------------------	-------------

900	630-760	80	607.8D25.760.090
-----	---------	----	------------------

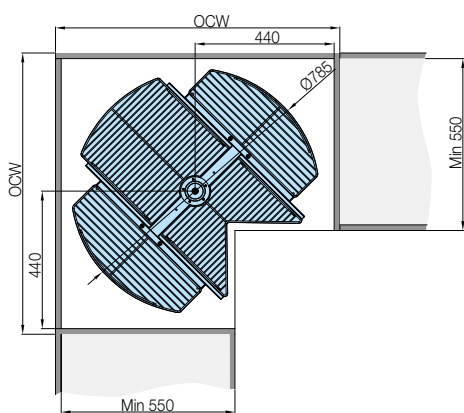

Kitchen Innerware Corner Solutions

- Soft close damping technology
- Left or right hand options
- Allows full access to unused space
- Polished chrome steel mesh baskets



Magic Corner Unit

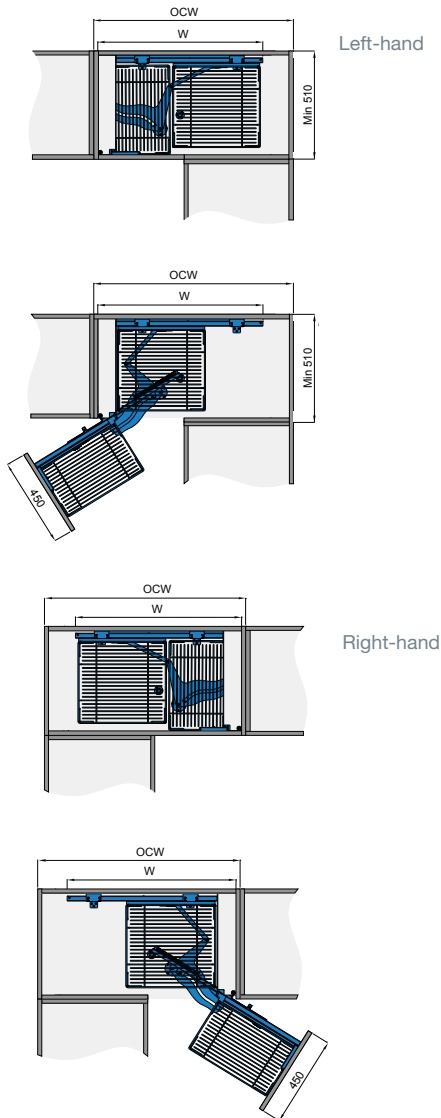

Opening direction	Suits outside cabinet width (mm)	Depth (mm)	Min dimensions (mm)	Weight capacity per frame (kg)	Item number
Left-hand	450	520	864-964	25	607.8D26.520.045
Right-hand	450	520	864-964	25	607.8D27.520.045

Kitchen Innerware Corner Solutions

· 270° 3/4 swivel basket



270° Lazy Susan Corner Unit

Suits outside cabinet width (mm)	Min. internal carcass depth (mm)	Cabinet height (mm)	Item number
800	710	565-790	607.8D25.070.090
900	820	720-1200	607.8D25.080.090

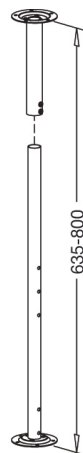
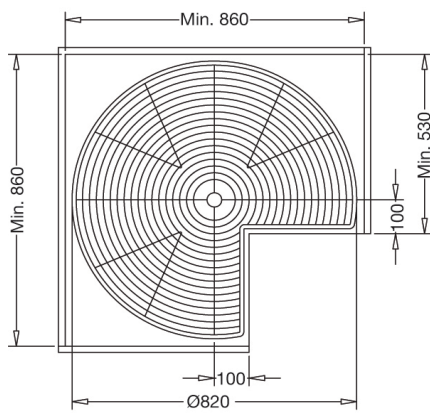

Kitchen Innerware Base Solutions

- Soft close damping technology
- Anti-slip solid base
- Hinged or panel door



Side Mount Pull-out Diamond Basket Utility Unit

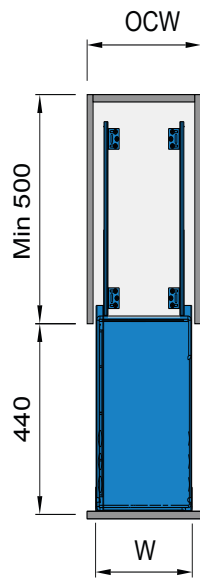

Opening direction	Suits cabinet width (mm)	Min. internal carcass depth (mm)	Height (mm)	Weight Capacity (kg)	Item number
Left-hand	200	500	595	25	607.8D92.465.020L
Right-hand	200	500	595	25	607.8D92.465.020R
Left-hand	300	500	595	25	607.8D92.465.030L
Right-hand	300	500	595	25	607.8D92.465.030R

Kitchen Innerware Base Solutions

- Soft close damping technology
- Polished chrome steel baskets
- 30kg load capacity



Narrow Side Mount Pull-out Utility Unit

Suits outside cabinet width (mm)	Min. internal carcass depth (mm)	Cabinet height (mm)	Item number
----------------------------------	----------------------------------	---------------------	-------------

150	500	Min. 545	607.8D80.500.015
-----	-----	----------	------------------

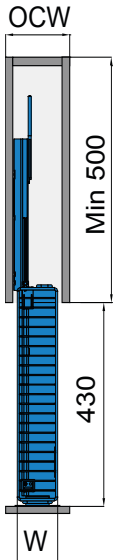

Kitchen Innerware Base Solutions

- Soft close damping technology
- Polished chrome steel mesh baskets
- Hinged or panel door



Side Mount Pull-out Utility Unit

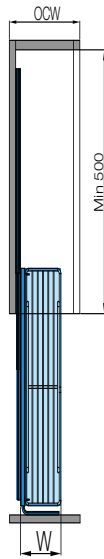

Opening direction	Suits cabinet width (mm)	Min. internal carcass depth (mm)	Height (mm)	Weight capacity (kg)	Item number
Left-hand	200	500	596	25	607.8D90.596.020L
Right-hand	200	500	596	25	607.8D90.596.020R
Left-hand	300	500	596	25	607.8D90.596.030L
Right-hand	300	500	596	25	607.8D90.596.030R

Kitchen Innerware Base Solutions

- Soft close damping technology
- Mounted on panel door
- Soft close bottom-mounted runners



Base Mount Pull-out Utility Unit

Suits cabinet width (mm)	Min. internal carcass depth (mm)	Height (mm)	Weight Capacity (kg)	Item number
400	500	595	30	607.8D91.465.040
450	500	595	30	607.8D91.465.045

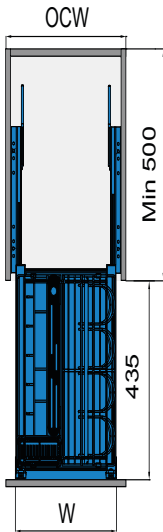

Kitchen Innerware Pantry Solutions

- Soft close damping technology
- 5 anti-slip base trays
- Solid base with glass basket
- Universal left and right hand opening
- Full extension 100kg load capacity
- Height adjustable from 1720-2020mm

						
		Suits outside cabinet width (mm)	Width (mm)	Depth (mm)	Height (mm)	Item number
Space Pantry Unit		500	445	500	1720-2020	607.8D57.197.050
		600	545	500	1720-2020	607.8D57.197.060
						<ul style="list-style-type: none"> • Min. internal carcass depth 535mm

Kitchen Innerware Pantry Solutions

- Soft close damping technology
- Polished chrome steel mesh baskets
- Full extension 100kg load capacity
- Height adjustable from 1860-2200mm
- Adjustable door mounting brackets for easy fitting



Pull-out Pantry Unit with Soft Close

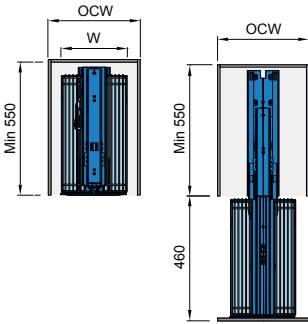

Suits outside cabinet width (mm)	Width (mm)	Depth (mm)	Height (mm)	Item number
300	250	500	1860-2200	607.8D55.222.030
400	345	500	1860-2200	607.8D55.222.040
450	395	500	1860-2200	607.8D55.222.045
500	445	500	1860-2200	607.8D55.222.050

· Min. internal carcass depth 535mm

Kitchen Innerware Pantry Solutions

- Soft close damping technology
- Polished chrome steel mesh baskets
- Full extension 60kg load capacity
- Universal left and right hand opening



Deluxe Pantry Unit

Suits outside cabinet width (mm)	Width (mm)	Depth (mm)	Height (mm)	Item number
450	384	455	1840-1970	607.8D56.197.045
600	534	455	1840-1970	607.8D56.197.060

· Min. internal carcass depth 535mm

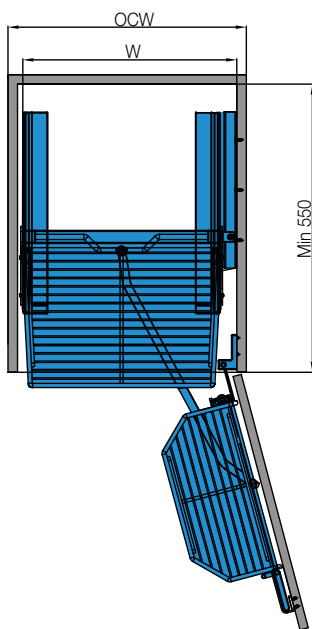

Kitchen Innerware Pantry Solutions

- Fits 400mm wide cabinets
- Steel with chrome baskets and grey frame

	Suits outside cabinet width (mm)	Height (mm)	Width (mm)	Item number
Compact Pull-out Pantry	400	935 - 1300	490	KA50106



Kitchen Innerware Wire Drawers

- Soft close damping technology
- Pull-out wire drawers for kitchen storage
- Polished chrome steel mesh baskets
- Weight capacity 40kg

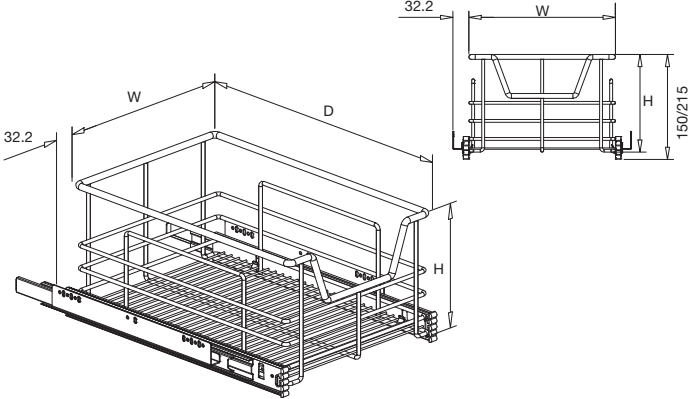
	Suits outside cabinet width (mm)	Width (mm)	Depth (mm)	Height (mm)	Item number
<p>Wire Drawers with Soft Close</p>  	450	410-418	453	200	607.8D15.200.045
	500	460-468	453	200	607.8D15.200.050
	600	560-568	453	200	607.8D15.200.060
	800	760-768	453	200	607.8D15.200.080
	900	860-868	453	200	607.8D15.200.090
	400	360-368	453	135	607.8D15.135.040
	450	410-418	453	135	607.8D15.135.045
	500	460-468	453	135	607.8D15.135.050
	600	560-568	453	135	607.8D15.135.060
	800	760-768	453	135	607.8D15.135.080
	900	860-868	453	135	607.8D15.135.090



Kitchen Innerware

Wire Storage Baskets

	Internal cabinet width (mm)	Depth (mm)	Height (mm)	Item number
Wire Storage Basket with slides	466	400	200	607.8F02.168.002
	566	400	200	607.8F02.170.002
	393	450	140	607.8F02.174.002
	393	450	200	607.8F02.172.002
	416	450	140	607.8F02.178.002
	416	450	200	607.8F02.176.002
· White finish				

Kitchen Accessories

Kitchen Towel Rails

	Arms	Length (mm)	Finish	Item number
<p>Tea Towel Rail</p>  <p>Made of steel</p>	2	470	Chrome	607.8G03.890.200
<p>D-shape Tea Towel Rail</p>  <p>Made of steel</p>		300	Chrome	607.8G00.905.300
		380	Chrome	607.8G00.905.380

Waste Bins

Tekno Softclose Hampers

- Hampers suitable for use with Tekform Drawer
- For Tekno waste bins see page 9.43



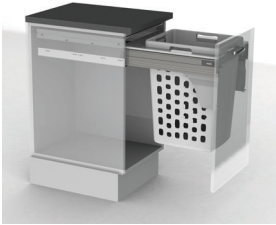

Laundry Hamper







Depth (mm)	Width (mm)	Height (mm)	To suit cabinet width (mm)	Capacity	Mounting	Closing	Item Number
510	368	575	400	1x 35L	Door	Soft Close	607.8G07.435.271
510	418	550	450	1x 48L	Door	Soft Close	607.8G07.450.351
510	568	575	600	2x 35L	Door	Soft Close	607.8G07.470.241

Laundry Innerware Hampers

- Wire basket laundry hamper solutions
- For Tekno Laundry Hampers → see page 9.45

	Height (mm)	Width (mm)	Depth (mm)	Item number
<p>Tilting Laundry Hamper</p> 	495	406	377	607.8E60.406.007
	<ul style="list-style-type: none"> · Includes flap stay · Chrome finish 			
<p>Laundry Hamper for Drawers</p> 	600	370	460	607.8E60.307.001
	<ul style="list-style-type: none"> · Mounts to drawer front and base · White powder coated finish 			

Wardrobe Innerware

	Finish	Profile	Length (mm)	Height (mm)	Width (mm)	Item number
Wardrobe Hanging Rail 	Chrome	Round	3000	25	25	607.8E20.025.407
	Chrome	Round	3000	19	19	607.8E20.019.317
	Chrome	Oval	3000	30	15	607.8E21.030.307
End Flange 	Chrome	Round		55	25	607.8E20.025.307
	Chrome	Round		50	19	607.8E20.019.307
	Chrome	Oval		50		607.8E21.030.204
	· To use with wardrobe hanging rail					
End Pillar 	Chrome	Round		80	25	607.8E20.025.107
	Chrome	Round		70	19	607.8E20.019.107
	Chrome	Oval		75		607.8E21.030.109
	· To use with wardrobe hanging rail					
Centre Pillar 	Chrome	Round		80	25	607.8E20.025.207
	Chrome	Round		70	19	607.8E20.019.207
	Chrome	Oval		75		607.8E21.030.209
	· To use with wardrobe hanging rail					

Wardrobe Sliding Track



GlideSoft RD

- Floor to ceiling panel system
- Takes 10mm or 4mm panel, glass or acrylic
- Centre door soft close option
- Maximum width 3.6m
- Minimum width 600mm
- Installation depth 76mm
- Maximum installation height 2480mm
- 60kg weight capacity per door

	Finish	Length (mm)	Item number
<p>GlideSoft RD Handle Profile</p> 	Aluminium	2400	608.8V02.010.003
<p>GlideSoft RD Handle U Profile</p> 	Aluminium	2400	608.8V02.010.004
<p>GlideSoft RD Top Track</p> 	Aluminium	3600	608.8V02.010.001
<p>GlideSoft RD Bottom Track</p> 	Aluminium	3600	608.8V02.010.002

Wardrobe Sliding Track

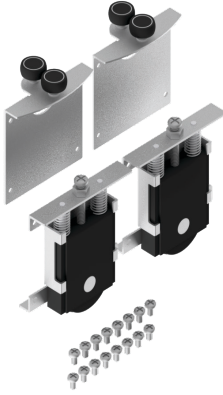
GlideSoft RD Fitting Kits

	Item number
<p data-bbox="215 886 529 910">GlideSoft RD 1 Door Fitting Kit</p> 	<p data-bbox="1150 886 1333 910">608.8V02.010.006</p> <p data-bbox="1150 934 1281 958">Kit includes:</p> <ul data-bbox="1150 958 1394 1035" style="list-style-type: none">· 2x top mechanism· 2x bottom mechanism· Fixing screws
<p data-bbox="215 1507 604 1531">GlideSoft RD Standard Close Stop Kit</p> 	<p data-bbox="1150 1507 1333 1531">608.8V02.010.010</p> <p data-bbox="1150 1555 1281 1579">Kit includes:</p> <ul data-bbox="1150 1579 1428 1637" style="list-style-type: none">· Standard rest mechanism· 2x support stops

Wardrobe Sliding Track

Titusoft SD100s



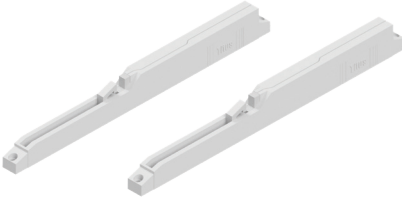
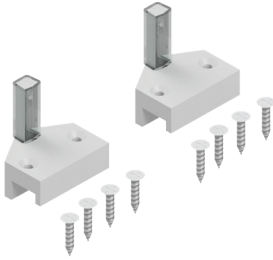

Soft Close Damping

- Compact design for bottom running tracks
- Effortless door opening
- Flexible mounting position
- 'ConfidentClose' with Titus damper

	Item number
Titusoft SD100s Side Door Damping Kit 	973.9060.380 Kit includes: <ul style="list-style-type: none">· 2x universal soft close dampers
Actuator for SD100s 	973.4451.010 Kit includes: <ul style="list-style-type: none">· 2x actuators· Fixing screws

Wardrobe Sliding Track



GlideSoft RD Products

	Length (mm)	Item number
<p>GlideSoft RD Brush Strip, 9.5mm</p> 	9.5	<p>608.8V02.010.012</p> <ul style="list-style-type: none"> · Brush strip for application to the back of the front door
<p>GlideSoft RD Brush Strip, 6mm</p> 	6	<p>608.8V02.010.013</p> <ul style="list-style-type: none"> · Brush strip for application to both sides of each door
<p>GlideSoft RD Gasket for 4mm Glass</p> 	3600	<p>608.8V02.010.014</p> <ul style="list-style-type: none"> · Applied to the back of the door as a wedge when using 4mm panels
<p>GlideSoft RD 20mm Coverstrip</p> 	2400	<p>608.8V02.010.005</p> <ul style="list-style-type: none"> · Thin aluminium strip used to cover the joint when using multiple panels for doors

Wardrobe Sliding Track

GlideSoft TP

- Cabinet based panel system
- For 16mm standard and 18mm routed panels
- Maximum width 3.6m
- Minimum width 600mm
- Installation depth 145mm
- Centre rest kit for centre doors
- 50kg weight capacity per door

	Finish	Length (mm)	Item number
GlideSoft TP Handle Profile 	Aluminium	2400	608.8V02.020.003
GlideSoft TP Handle U Profile 	Aluminium	2400	608.8V02.020.004
GlideSoft TP Top Track  	Aluminium	3600	608.8V02.020.001
GlideSoft TP Bottom Track  	ABS	3600	608.8V02.020.002

Wardrobe Sliding Track

GlideSoft TP Fitting Kits

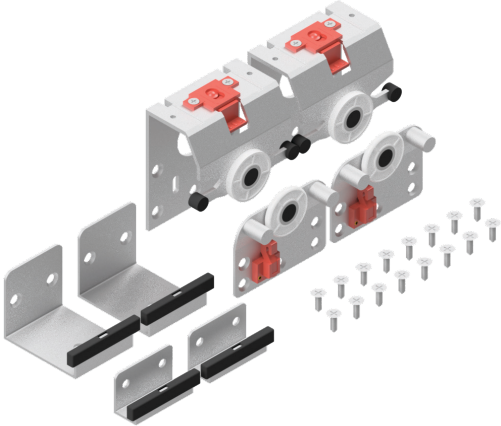
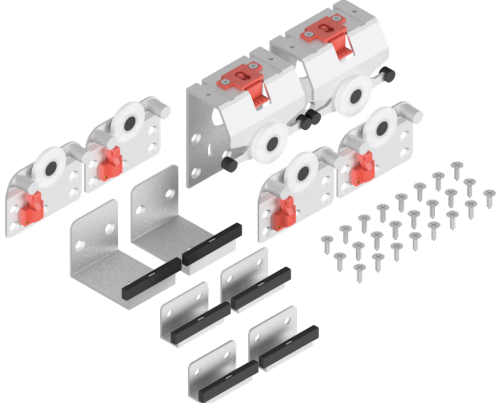

	Item number
<p data-bbox="215 886 524 910">GlideSoft TP 2 Door Fitting Kit</p> 	<p data-bbox="1150 886 1333 910">608.8V02.020.005</p> <p data-bbox="1150 929 1281 953">Kit includes:</p> <ul data-bbox="1150 958 1489 1086" style="list-style-type: none">· 1x Type 1 top mechanism set· 1x Type 2 top mechanism set· 1x Type 1 bottom rail runner set· 1x Type 2 bottom rail runner set· Fixing screws
<p data-bbox="215 1507 524 1531">GlideSoft TP 3 Door Fitting Kit</p> 	<p data-bbox="1150 1507 1333 1531">608.8V02.020.006</p> <p data-bbox="1150 1550 1281 1574">Kit includes:</p> <ul data-bbox="1150 1579 1489 1707" style="list-style-type: none">· 1x Type 1 top mechanism set· 2x Type 2 top mechanism set· 1x Type 1 bottom rail runner set· 2x Type 2 bottom rail runner set· Fixing screws

Wardrobe Sliding Track

GlideSoft TP

Closing Options

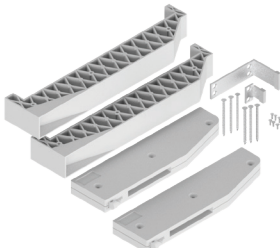
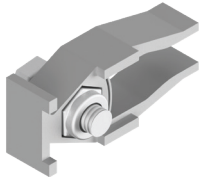
- Cabinet based panel system
- For 16mm standard and 18mm routed panels
- Maximum width 3.6m
- Minimum width 600mm
- Installation depth 145mm
- Centre rest kit for centre doors
- 50kg weight capacity per door



	Item number
<p>GlideSoft TP Left & Right Damping Kit</p> 	<p>608.8V02.020.007</p> <p>Kit includes:</p> <ul style="list-style-type: none"> · 2x soft close dampers · 1x large actuator · 1x small actuator · 2x support blocks · Fixing screws
<p>GlideSoft TP Standard Close Stop Kit</p> 	<p>608.8V02.020.008</p> <p>Kit includes:</p> <ul style="list-style-type: none"> · Standard rest mechanism
<p>GlideSoft TP Centre Rest Kit</p> 	<p>608.8V02.020.009</p> <p>Kit includes:</p> <ul style="list-style-type: none"> · Centre rest mechanism

Drawer Inserts

Drawer Inserts

Kombi Cutlery Trays

- Full usage of the drawer
- Suitable for all drawer types
- High quality plastic material
- Easy clean surface

	To suit drawer width (mm)	Depth (mm)	Width (mm)	Item number	Metallic	White
Kombi Cutlery Tray, 400mm 	400	441-500	301-350	607.8F22.040 →		201
	400	441-500	301-350	607.8F22.040 →	202	
Kombi Cutlery Tray, 450mm 	450	370-440	351-400	607.8F22.045 →	102	
	450	441-500	351-400	607.8F22.045 →		201
	450	441-500	351-400	607.8F22.045 →	202	
Kombi Cutlery Tray, 500mm 	500	441-500	401-450	607.8F22.050 →		201
	500	441-500	401-450	607.8F22.050 →	202	

Drawer Inserts

Kombi Cutlery Trays

- Full usage of the drawer
- Suitable for all drawer types
- High quality plastic material
- Easy clean surface

	To suit drawer width (mm)	Depth (mm)	Width (mm)	Item number	Metallic	White
Kombi Cutlery Tray, 550mm 	550	441-500	451-500	607.8F22.055 →		201
	550	441-500	451-500	607.8F22.055 →	202	
Kombi Cutlery Tray, 600mm 	600	370-440	501-550	607.8F22.060 →	102	
	600	441-500	501-550	607.8F22.060 →		201
	600	441-500	501-550	607.8F22.060 →	202	
Kombi Cutlery Tray, 650mm 	650	441-500	551-600	607.8F22.065 →		201
Kombi Cutlery Tray, 700mm 	700	370-440	601-650	607.8F22.070 →	102	
	700	441-500	601-650	607.8F22.070 →		201
	700	441-500	601-650	607.8F22.070 →	202	

Drawer Inserts

Kombi Cutlery Trays

- Full usage of the drawer
- Suitable for all drawer types
- High quality plastic material
- Easy clean surface

	To suit drawer width (mm)	Depth (mm)	Width (mm)	Item number	Metallic	White
Kombi Cutlery Tray, 800mm 	800	441-500	701-750	607.8F22.080 →		201
	800	441-500	701-750	607.8F22.080 →	202	
Kombi Cutlery Tray, 900mm 	900	441-500	801-850	607.8F22.090 →		201
	900	441-500	801-850	607.8F22.090 →	202	
Kombi Cutlery Tray, 1000mm 	1000	441-500	901-950	607.8F22.100 →		201
	1000	441-500	901-950	607.8F22.100 →	202	

Drawer Inserts

Cutlery Inserts

- High-impact Styrene
- Injection moulds
- Uniform thickness
- Trim for versatility to suit most drawers

	To suit drawer width (mm)	Depth (mm)	Width (mm)	Item number	Metallic	White
Cutlery Insert, 450mm 	450	346-435	306-450	607.8F03.101 →		001
	450	362-484	357-445	607.8F03.102 →		001
Cutlery Insert, 550mm 	550	373-483	482-532	607.8F03.107 →		001
Utensil Trays, 450mm 	450	441-500	351-400	607.8F23.045 →		201
	450	441-500	351-400	607.8F23.045 →	202	
Utensil Trays, 600mm 	600	441-500	501-550	607.8F23.600 →		201
	600	441-500	501-550	607.8F23.600 →	202	

Drawer Inserts



Spice Trays

- High-impact Styrene
- Injection moulds
- Uniform thickness
- Trim for versatility to suit most drawers

	To suit drawer width (mm)	Depth (mm)	Width (mm)	Item number	White	Grey
Spice Tray, 450mm 	450	430-520	350-390	607.8G23.045 →	001	
	450	430-520	350-390	607.8G23.045 →		002
Spice Tray, 500mm 	500	430-520	400-440	607.8G23.050 →		002
Spice Tray, 600mm 	600	430-520	500-540	607.8G23.060 →	001	
	600	430-520	500-540	607.8G23.060 →		002
Spice / Cutlery Tray, 800mm 	800	430-520	700-740	607.8G24.080 →	001	
	800	430-520	700-740	607.8G24.080 →		002
Spice / Cutlery Tray, 900mm 	900	430-520	800-840	607.8G24.090 →	001	
	900	430-520	800-840	607.8G24.090 →		002

Drawer Inserts Utensil Organisers

- Durable and attractive stainless steel
- Designed to provide a space left or right of the tray for long utensils

	Depth (mm)	Width (mm)	Item number	Stainless steel
Triple Cutlery Organiser 	450	280	607.8E12.208 →	459
	500	280	607.8E12.208 →	509
	550	280	607.8E12.208 →	559
Cutlery Utensil Organiser, 208mm Range 	450	208	607.8E13.208 →	459
	500	208	607.8E13.208 →	509
	550	208	607.8E13.208 →	559
Cutlery Utensil Organiser, 309mm Range 	450	309	607.8E13.308 →	459
	500	309	607.8E13.308 →	509
	550	309	607.8E13.308 →	559
Cutlery Utensil Organiser, 377mm Range 	450	377	607.8E13.377 →	459
	500	377	607.8E13.377 →	509
	550	377	607.8E13.377 →	559

Drawer Inserts Utensil Organisers

- Durable and attractive stainless steel
- Designed to maximise your drawer space and versatility

	Depth (mm)	Width (mm)	Item number	Stainless steel
Double Utensil Organiser 	450	202	607.8E12.202 →	459
	500	202	607.8E12.202 →	509
	550	202	607.8E12.202 →	559
Double Utensil Organiser, Large 	450	291	607.8E12.291 →	459
	500	291	607.8E12.291 →	509
	550	291	607.8E12.291 →	559
Single Utensil Organiser 	450	105	607.8E12.105 →	459
	500	105	607.8E12.105 →	509
	550	105	607.8E12.105 →	559

Waste Bins

Waste Bins

Single Bins

- Removable hi-impact bin for easy cleaning
- Right or left opening



Tidy Bin 8L

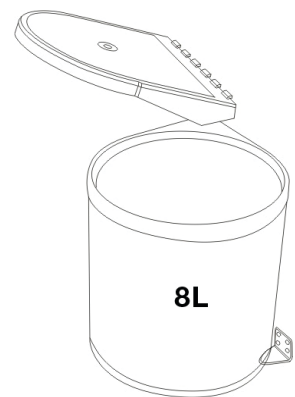

Depth (mm)	Width (mm)	Height (mm)	Capacity	Mounting	Item number	Stainless steel	White
300	300	280	8L	Door	607.8G03.008 →		201
300	300	280	8L	Door	607.8G03.008 →	209	

- Automatic opening lid

Tidy Bin 12L

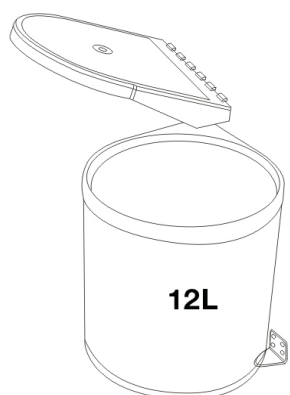

290	290	320	12L	Door	607.8G03.012 →		201
-----	-----	-----	-----	------	----------------	--	-----

- Automatic opening lid

Waste Bins

Single Bins

- Soft close damping technology
- Closed lid position minimises odours
- Removable hi-impact bin for easy cleaning

	Depth (mm)	Width (mm)	Height (mm)	Capacity	Mounting	Item number	White
Bottom Mounted Tidy Bin	360	262	310	15L	Bottom	607.8G03.115 →	101
<ul style="list-style-type: none"> • Ideal for apartment/townhouse environment • Small bin to suit vanity • Perfect for under sink applications • Simple DIY installation to the base of the cabinet • Soft close ball bearing runners 							



Waste Bins

Pull-out Twin Bins

- Closed lid position minimises odours
- Removable hi-impact plastic bins for easy cleaning



Twin Bin Pull-out with Metal Frame, Bottom Mounted



Twin Bin Pull-out with Metal Frame, Door Mounted



Depth (mm)	Width (mm)	Height (mm)	Capacity	Mounting	Item number	Grey	White
510	262	420	30L	Bottom	607.8G03.030 →		001
510	262	420	30L	Bottom	607.8G03.030 →	007*	
<ul style="list-style-type: none"> · Right or left opening · Sturdy, hi-impact frame · 1x 20L bucket and 1x 10L bucket · To suit 300mm cabinet 							
490	262	420	30L	Door	607.8G06.130 →		231
<ul style="list-style-type: none"> · Sturdy, hi-impact frame · 1x 20L bucket and 1x 10L bucket · To suit 300mm cabinet 							

Waste Bins

Pull-out Twin Bins

- Closed lid position minimises odours
- Removable hi-impact plastic bins for easy cleaning



Twin Bin Pull-out Double Bins with Metal Frame



Depth (mm)	Width (mm)	Height (mm)	Capacity	Mounting	Item number	White
510	340	320	2x 15L	Bottom	607.8G06.030 →	101
510	340	380	2x 18L	Bottom	607.8G06.036 →	001
490	340	320	2x 15L	Door	607.8G06.030 →	201
490	340	380	2x 18L	Door	607.8G06.036 →	201

- Ideal for low shelf applications or plumbing
- Sturdy, hi-impact frame
- To suit 400mm cabinet

Twin Bin XL Pull-out with Metal Frame





470	464	470	1x 28L 2x 17L	Door	607.8G06.156 →	251
470	564	470	2x 28L	Door	607.8G06.156 →	261

- Sturdy, hi-impact frame
- Door panel attaches directly to bin

Waste Bins

Tekno Softclose Bins

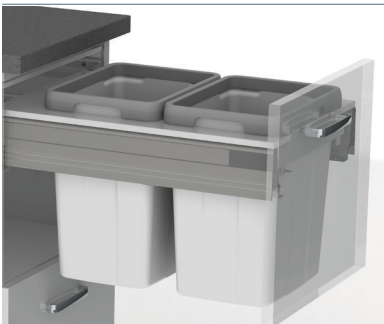

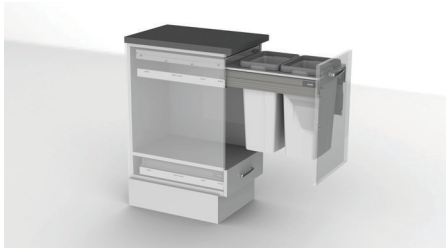
- To suit 400mm outside cabinet width
- Bins suitable for use with Tekform Drawer
- For Tekno Laundry Hampers, see page 9.20

	Depth (mm)	Width (mm)	Height (mm)	Capacity	Mounting	Closing	Item number
 <p>Tekno Bin with Soft Close 26L</p>	506	368	340	35L	Door	Soft Close	607.8G06.304.040
<ul style="list-style-type: none"> · Includes 2x 13L buckets 							
 <p>Tekno Twin Bin with Soft Close 36L</p>	506	368	470	36L	Door	Soft Close	607.8G06.302.040
<ul style="list-style-type: none"> · Includes 2x 18L buckets 							
 <p>Tekno Twin Bin with Soft Close 35L</p>	506	368	570	35L	Door	Soft Close	607.8G06.300.040
<ul style="list-style-type: none"> · Includes 1x 35L bucket 							

Waste Bins

Tekno Softclose Bins

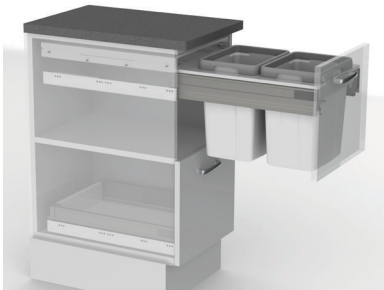
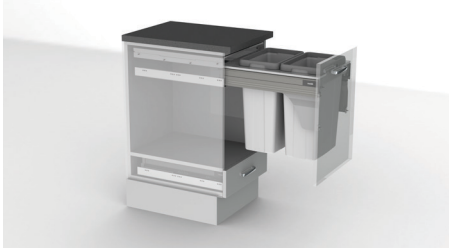

- Bins suitable for use with Tekform Drawer
- For Tekno Laundry Hampers, see page 9.20

	Depth (mm)	Width (mm)	Height (mm)	Capacity	Mounting	Closing	Item number
 <p>Tekno Bin with Soft Close 42L</p>	506	418	470	2x 21L	Door	Soft Close	607.8G04.442.171
	506	418	570	2x 27L	Door	Soft Close	607.8G04.454.151
<ul style="list-style-type: none"> • To suit 450mm cabinet width 							
 <p>Tekno Twin Bin with Soft Close 39L</p>	506	468	470	1x 21L 2x 9L	Door	Soft Close	607.8G04.439.151
<ul style="list-style-type: none"> • To suit 500mm cabinet width 							
 <p>Tekno Twin Bin with Soft Close 70L</p>	506	562	506	2x 35L	Door	Soft Close	607.8G06.307.040
<ul style="list-style-type: none"> • To suit 600mm cabinet width 							

Waste Bins

Tekno Softclose Bins

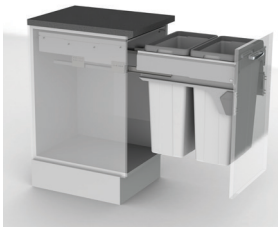
- Bins suitable for use with Tekform Drawer
- For Tekno Laundry Hampers, see page 9.20

	Depth (mm)	Width (mm)	Height (mm)	Capacity	Mounting	Closing	Item number
 <p>Tekno Undermount Bin</p>	506	412-418	590	70L	Undermount	Soft Close	607.8G06.235.450
 <p>Tekno Side Mount Bin</p>	510	312	350	26L	Side Mount	Soft Close	607.8G08.526.281
	510	312	480	36L	Side Mount	Soft Close	607.8G08.536.281
 <p>Spare Tekno Softclose 400mm Bin Frame</p>	513	368				Soft Close	607.8G06.308.040
<p>Spare Tekno Softclose 600mm Bin Frame</p>	513	568				Soft Close	607.8G06.309.040
<p>Spare Tekno Bin Bucket</p>				18L			607.8G06.310.180
<p>Spare Tekno Bin Bucket</p>				13L			607.8G06.309.130
<p>Spare Tekno Bin Bucket</p>				35L			607.8G06.309.350
	<ul style="list-style-type: none"> · Replacement parts for Tekno Bins 						